

## EAGLE is a "Snap" to Erect

- Headers & jambs fit smoothly into the rough opening, to be easily plumbed & secured
- Simple matter to attach the hardware & hang the door
- EAGLE's unique casing, which snaps on last, overlaps & hides wallpaper cuts & paint splatters
- Profiles are available in standard 1-1/2" or 2"
- No sill starter/ blocking needed
- 4-1/2" x 4-1/2" Hinges
- ANSI Strike
- No Extended Lip Strike Required
- 1" Wide Door Stop
- No Additional Bracket needed for Parallel Arm Closer
- Heavy-duty All Aluminum Hinge Backer
- Mitre Corners Available
- Double-Egress Frame



Clear  
Anodized



Standard  
Black



Standard  
White



Standard  
Bronze



Standard  
Grey



Champagne

### PREMIUM HARDWARE

- Heavy Weight Hinge preps
- Electric Hinge preps
- 5" x 5" Hinge preps
- Concealed Closers
- EPT – Concealed & Hinge types
- Electric Strikes - All types
- SOSS Hinges - Concealed Hinges
- Concealed Overhead Stops
- Flush Bolts
- Backers Included & Installed

## Aluminum Frames With Glazing

Non-Rated / 20 - 45 Minute Fire-Rated



Pat. No. US 10,871,024 B2



No Field Notching of Trim Required

### Rough Opening for 1-1/2" or 2" profile:

Opening Size + 3/4" each side

Example: 3070 Frame

$3/4" + 36" \text{ width} + 3/4" = 37-1/2"$  rough opening

Example: 3070 Frame with 1'-0" Sidelite

$3/4" + 36" \text{ width} + 1-1/2" \text{ profile} + 1'-0" \text{ sidelite} + 3/4" = 4'-3"$

### All Throats Feature:

Flush Glazing 3-1/2" to 16-1/2" walls in 1/8" increments



**AVALON**  
**INTERNATIONAL**  
**ALUMINUM**

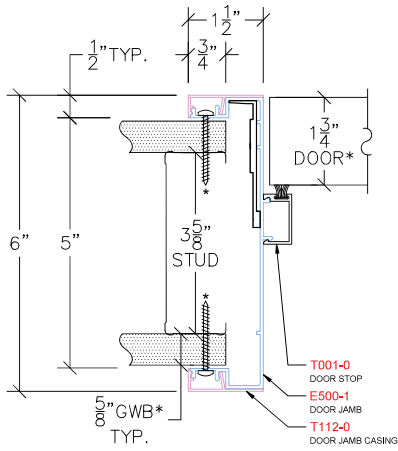

E100 - DOOR JAMB

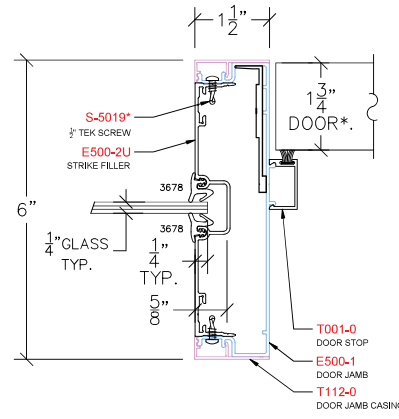

E150 - DOOR JAMB SIDELIGHT

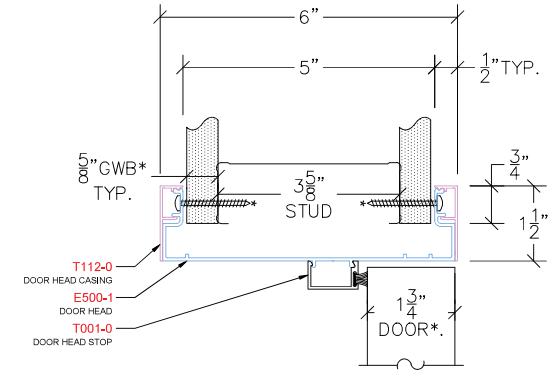

E200 - DOOR HEAD

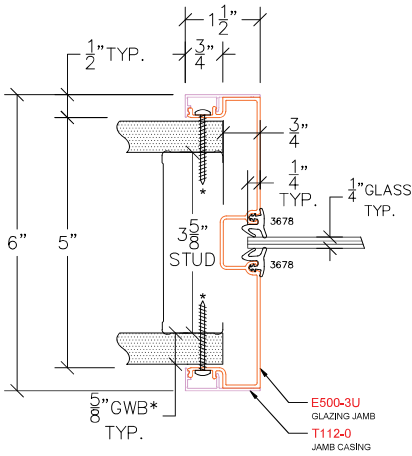

E300 - GLAZING JAMB

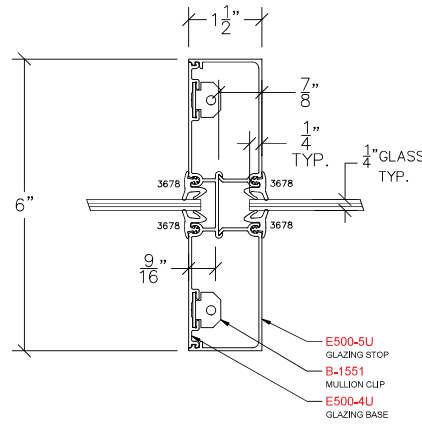

E305 - GLAZING INTERMEDIATE VERTICAL

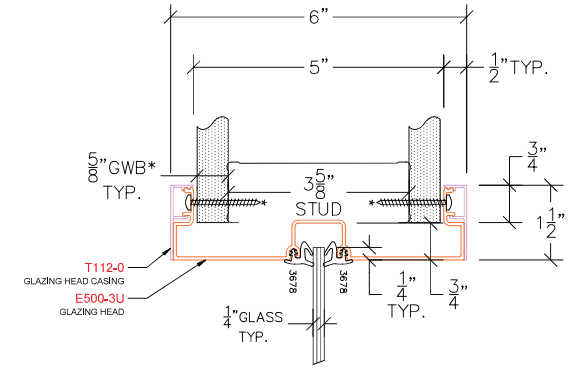

E400 - GLAZING HEAD

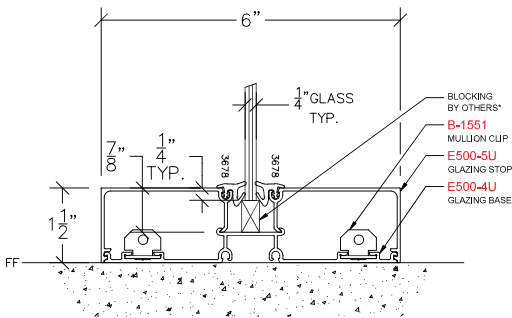

E420 - GLAZING SILL

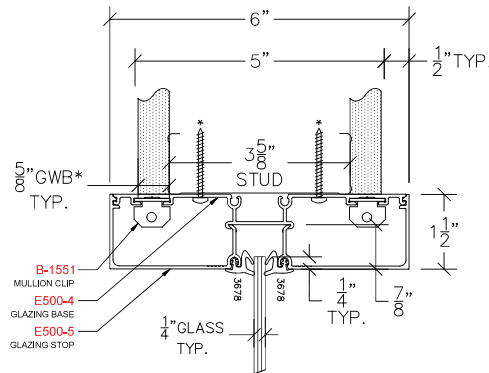

E425 - GLAZING HEAD

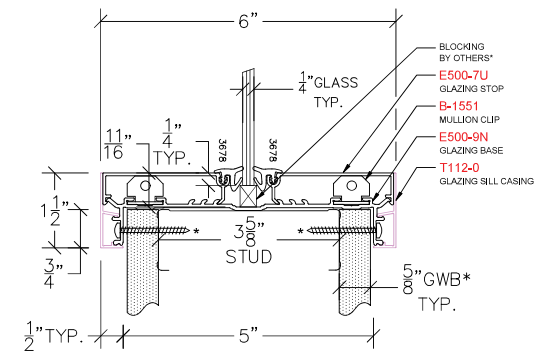

E430 - GLAZING SILL KNEEWALL