

AVALON EAGLE 500

E425 – GLAZING HEAD
PROFILE: 2" TRIM

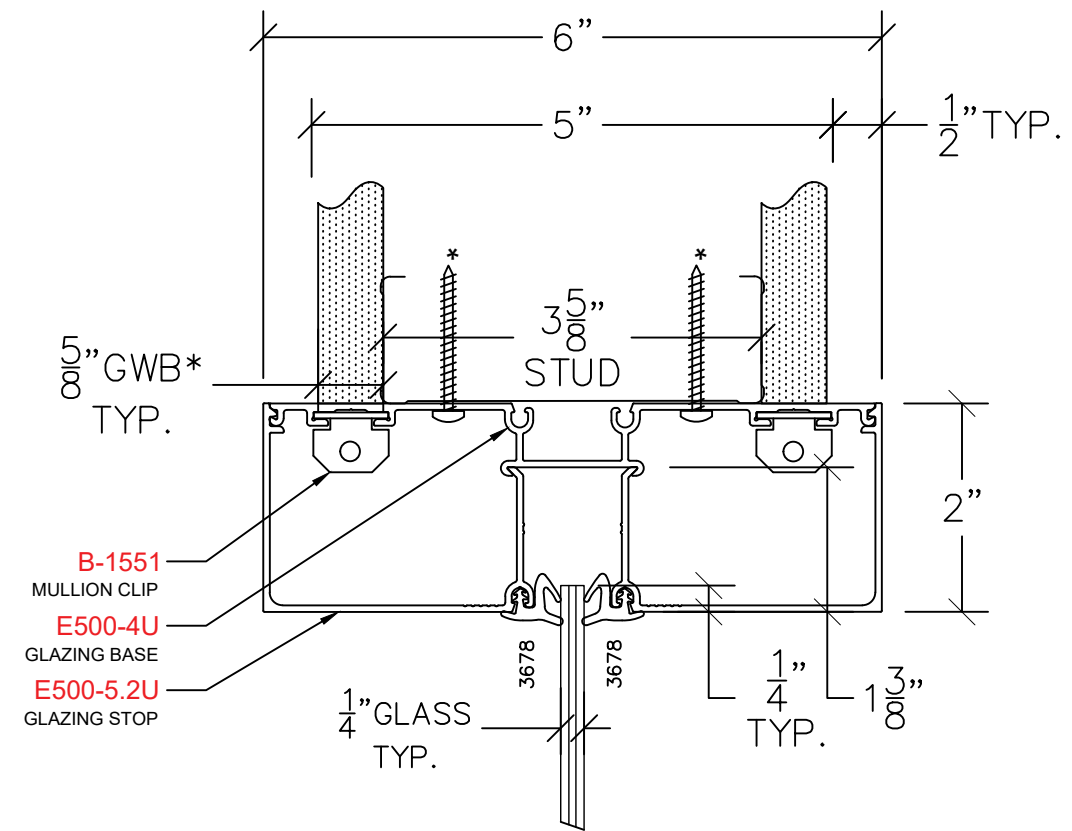

NOTE: STANDARD GLASS BITE $\frac{1}{4}$ "



P: (503)885-9494
W: AVALONINT.COM